

The

# FLASH!

The Newsletter of  
The **Colorado Radio Collectors**  
Antique Radio Club

Volume 36, Issue 2

Next CRC Meeting - March 16th

March/April 2025

## Post Auction Projects

by Rich Kuberski CRC Member

Last year, I attended the auction determined not to buy anything. I even left my checkbook at home. Naturally, I browsed through all the items up for sale and decided there was nothing I particularly wanted. However, as the auction progressed, I found myself bidding on several items, mostly because they seemed undervalued. As fate would have it, I ended up going home with seven items.

One of the items was a Hallicrafters S-36 UHF receiver (\$35). I did not notice that it was a UHF receiver when bidding, but it was in great shape and inexpensive. On my bench, it powered up and seemed like it wanted to work, but something was clearly wrong. Testing all the tubes revealed one weak tube, which I replaced, but that wasn't the issue. I also replaced the three electrolytic capacitors, that wasn't it either. Upon closer inspection, I found that the three acorn tubes were installed backward. After correcting this, the radio worked perfectly.



Since I really did not need it, I decided to sell it on eBay. I set the price at \$275, and it was sold on the first day. The buyer paid around \$100 for shipping, as it weighed 86 pounds after I prepared it for shipment.

The manual had a clear diagram illustrating the correct installation of the acorn tubes.

Next, I examined the Pioneer TX-7500 AM/FM receiver (\$5). The power switch's tip was broken off, yet it still functioned. I powered it up, and the tuner worked fine. Searching for a replacement switch, I found an original priced at \$165, which I wasn't willing to pay. Instead, I opted for a black panel switch—a simple SPST switch, easy to mount, and it works perfectly. It sold on eBay for \$51.

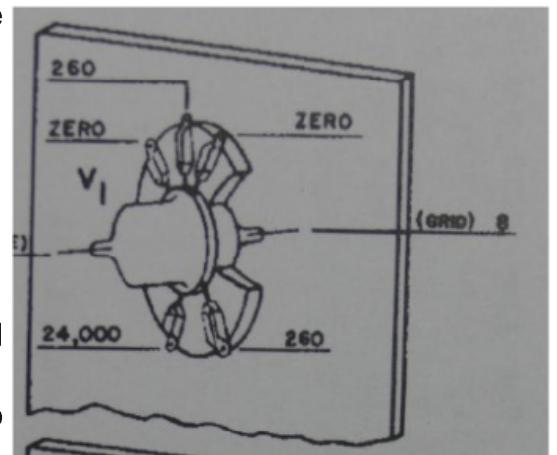

(Continued on page 3)



The FLASH! (c) 2025, All Rights Reserved.

Newsletter for The Colorado Radio Collectors Club, founded in the Fall of 1988

"Dedicated to the preservation and education of wireless, antique radio, television, and associated equipment"

**CRC MEETINGS:** Meetings are held on the 3rd Sunday of every other month starting in January at 1 :00 pm. The meetings consist of business, "show & tell", raffles, auctions, swap meets, technical discussions and other subjects of interest. Visitors are welcome!!

**CRC MEMBERSHIP:** Current annual dues are \$20 and membership in the CRC runs from January to January. New memberships will be prorated to the following January. Members are entitled to attend meetings, participate in our Spring show and our Fall auction, and receive our newsletter, **The Flash!**. Submit dues payable to: **Merril Campbell - 4723 Woodbury Dr. - Colorado Springs, CO 80915**

**UPCOMING EVENTS:** March 16th, 2025 CRC meeting - Highlands Ranch Library, Event Hall A, April 13th, 2025 - Vintage Voltage, Nat. Western Complex., May 11th, 2025 CRC Meeting- Highlands Ranch Library, Event Hall A

### CRC Contact Information

<b>President</b> Paul Heller 303-432-0434 phesopheon@comcast.net	<b>The Flash! Editor</b> Bill Potorti 970-342-3106 billpot@gmail.com	<b>eGroup posting address:</b> <a href="https://groups.google.com/g/colorado-radio-collectors">https://groups.google.com/g/colorado-radio-collectors</a>
<b>Vice-President</b> Bill Lettow 480-730-6058 LETTOW@Yahoo.com	<b>CRC Photographer</b> Jerry Stone jerrystone967@gmail.com	<b>Website address:</b> <a href="http://coloradoradiocollectors.com/CRC2/">http://coloradoradiocollectors.com/CRC2/</a>
<b>Treasurer</b> Merril Campbell 719-596-3482 campbell321 @juno.com	<b>CRC Facebook Group address:</b> <a href="https://www.facebook.com/groups/1132691767366259">https://www.facebook.com/groups/1132691767366259</a>	<b>Webmaster</b> Paul Heller phesopheon@comcast.net

## MESSAGE FROM THE PRESIDENT



Hi Everyone. I hope you are enjoying The Flash! It is not only useful for all the great articles, this time thanks to Rich Kuberski, but it is also the go-to place for club news.

What did you do with some of the items you won at the auction? Why not write about it in the flash? This kind of thing is interesting to all club members, and it's not that hard.

Volunteers! Thanks Bill Potorti, our new editor for The Flash! Thanks Bill Lettow, our new club vice president. Thanks Jerry Stone, our new (well, a few months now) club photographer. Thanks Steve Touzalin for helping me with the website. Thanks Scott Thomas for helping Merrill if he needs it.

We need your help! At some point, Merrill will stop waiting and hoping and will choose to step away. He has certainly earned that right. When he does, we will need a treasurer. No treasurer, no club. He has been asking to pass the baton for some time now. Please consider becoming Treasurer.

Our spring show is coming up! Please attend the March meeting if you can so we can make our plans. I look forward to seeing you there.

Paul

(Continued from page 1)

**Before:** Broken Power Switch



**After:** New power switch installed on the left side



Then there was the Hickok 6000 tube tester (\$20). I had an advantage, not because I'm an expert in these units, but because I know an expert: Club member Bill Eccher. With his help diagnosing and confirming the unit's condition, I replaced the defective analog meter with a digital one. Bill provided some of the parts, and I bought the rest. It wasn't technically difficult and turned out great.

In the photo below you can see the meter reading of 50.0.

The original analog meter is to be adjusted to read mid scale when the unit is turned on. The digital meter scale goes from 0 – 100. So, when it reads 50.0 the unit is adjusted to give accurate heater voltages. You can see the POWER switch on the middle left of the photo. The power switch is also a rheostat for making this fine adjustment.

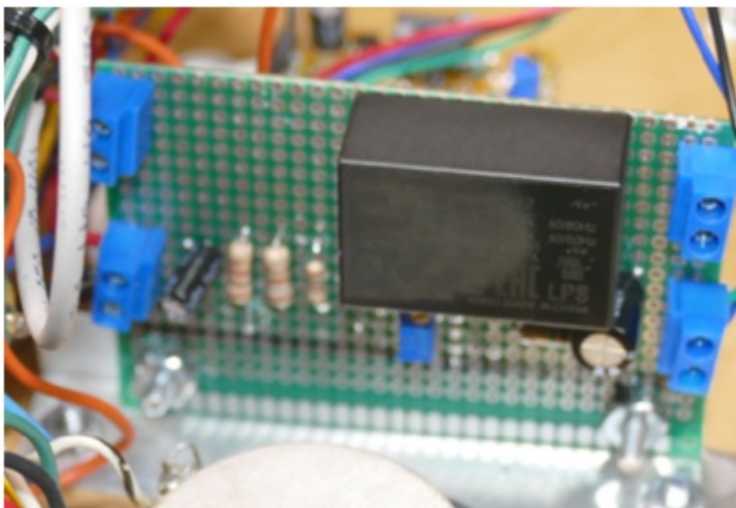

**New circuit board:** To support the new digital meter. The small black transformer powers the digital meter, and the rest of the circuit adjusts the voltage output to ensure accurate readings.

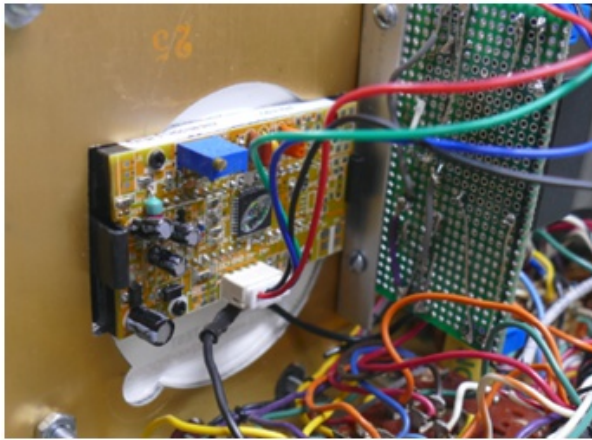

**Back view:** Digital meter and installed circuit board

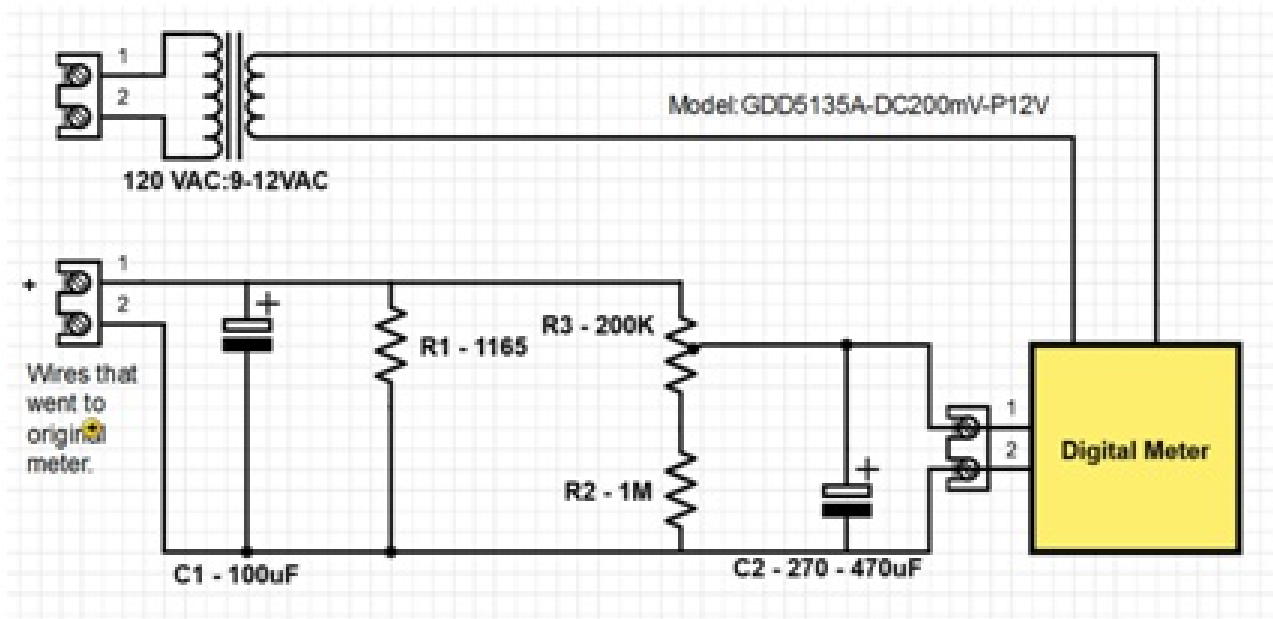

I also purchased a Coca-Cola novelty radio (\$10), which is solid-state and completely dead. I opened it up and hotwired it with a 3-volt battery and it works. It seems that it was suffering from corroded battery terminal syndrome and a broken solder joint on the circuit board. Fortunately, these are things I can fix.



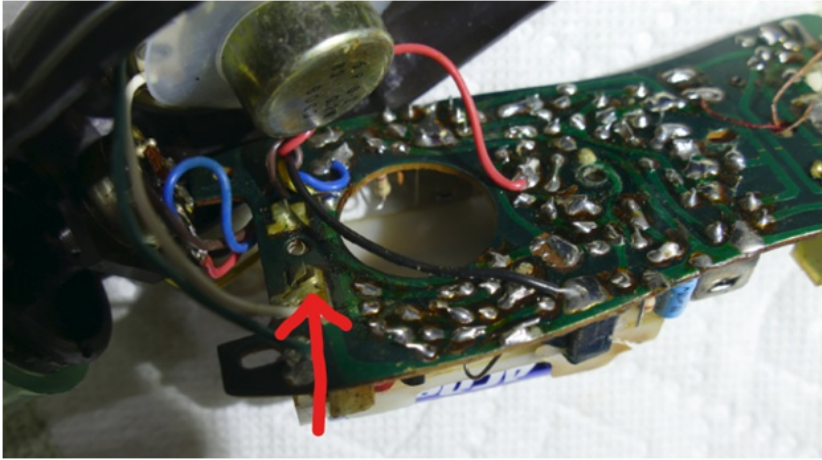

See the broken solder joint



Another item was a Hickok Model AC 51 tube tester, circa 1936, which nobody bid on, so I got it for \$5. It has problems and may never get fixed, but look for it in a display of tube testers at the April show.

I also bought an incomplete horn speaker. It was missing its base and was mounted on a wheel hub. Well, in my vast pile of junk, I have a base with no horn. My base is missing the electronics. So, I once again went into my pile of junk and found a small speaker that would fit in the base. The horn was not a perfect mate to my base, but with two "O" rings, it now looks, and works, just fine. No, it's not a high impedance speaker, but it will work with the post 1920's era radios.

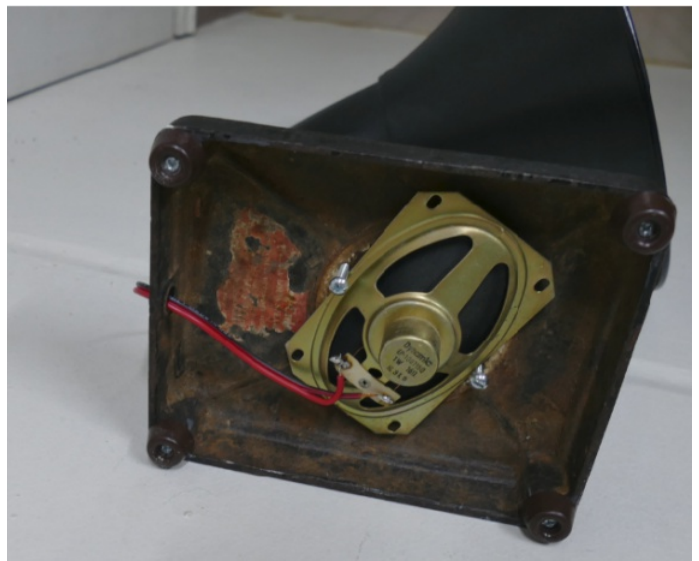

The one item I can truly use is the Triplet 4800 digital multimeter. It's in great physical condition and works perfectly.



All in all, it was a fine day of bidding on unneeded items. The auction is as much about the free lunch and spending time with friends as it is about getting more "STUFF."

## **MESSAGE FROM THE EDITOR**

I have stepped into the position of the Flash! editor.

I want to express my thanks to Steve Touzalin and Larry Snyder for all the work they've done in the past to make the Flash! what it is, as well as their assistance in helping me learn the ropes of the job.

Please contact me ([billpot@gmail.com](mailto:billpot@gmail.com)) with any comments, critiques, or advice during this transition.

As always, articles are always welcome.



*Bill*

### *This Little Radio Went to NEWMAN'S . . .*



**FRANKLIN D. NEWMAN**  
2950 PORTER ROAD                      DIAL 2-5855

*Guaranteed Radio Servicing*

# A Tribute To Wayne

by Rob Beyer - CRC Member

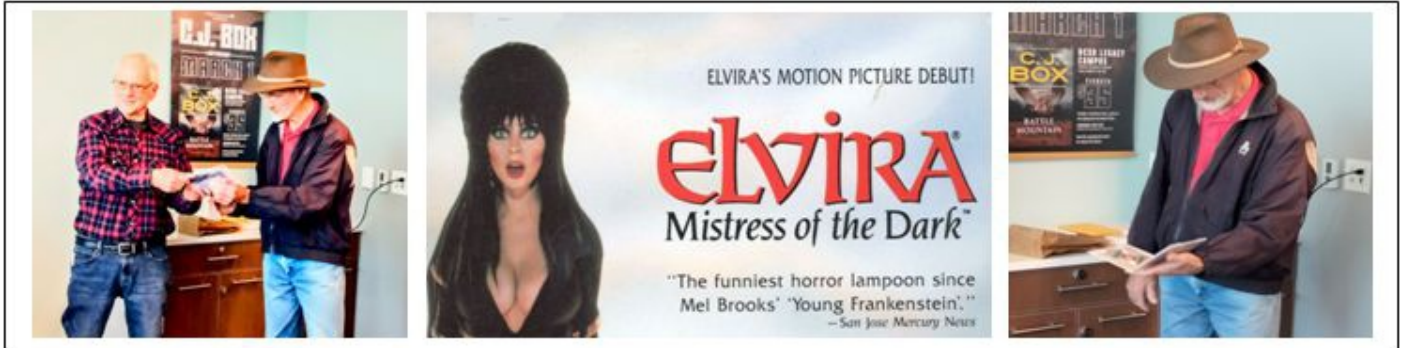

Recently since Larry Weide was moving out west, our "CRC" club gathered to help move/sell and store the remainder of Larry's radios, etc. It was decided to have an auction of the remainder for the club members via internet. Wayne Russert volunteered the use of his big barn for the event. Some of the members, including myself, had never seen this awesome barn and all the interesting things within. A few of us couldn't help but



notice a huge poster of Colorado's own "Mistress of the Dark", Elvira! (Cassandra Peterson). Wayne had been to her families' restaurant in Colorado Springs and became a "fan".

I asked Wayne had he seen the movie she made or any of her TV work? He hadn't, and that's when I got the idea, to surprise him (for all he does for the club) with a DVD of her first

movie, and another of one of her TV episodes. (making fun of a low budget horror movie)

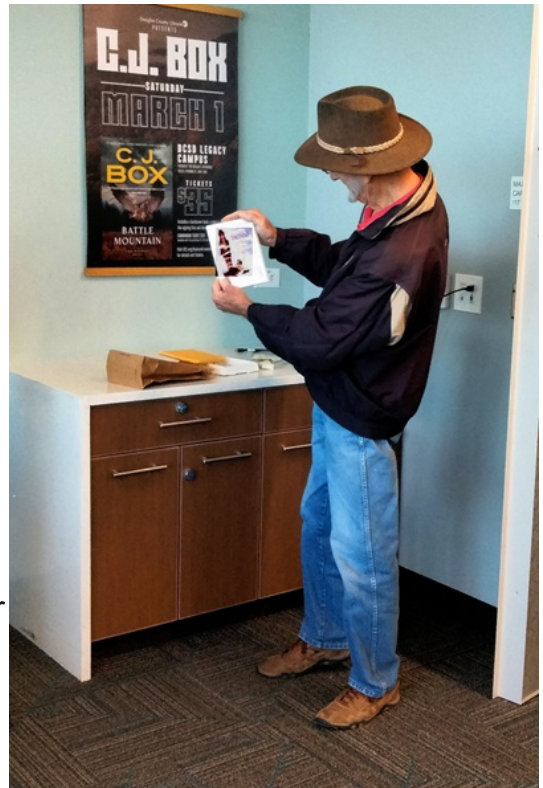

## NOTICE

As of now, these are the dates for the club meetings for the remainder of the year:

March 16th - Highlands Ranch Library, Event Hall A 1PM

April 13th - Club Show, National Western Complex - Expo Hall, 4655 Humboldt St., Denver

May 18th - Castle Rock Library 1PM

July 20th - Castle Rock Library 1PM

August/September Auction - Tentatively August 17th - Stay Tuned!

September 21st - Highlands Ranch Library, Event Hall A 1PM

November 16th - Castle Pines?

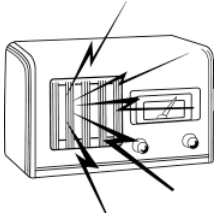

# The Latest CRC Club News



Mother Nature decided not to cooperate and our January 19th meeting had to be rescheduled to January 26th in the Highlands Ranch Library.



Photo courtesy of Rich Kubersky

Paul Heller was out of town, so vice-president Michael Cook began officiating. We had 25 attendees, including 3 new members - Daniel Qualman, Joann Wooley, and Kurtis Mitchell. Merrill Campbell gave the treasurers report. We have \$9431 in our club fund.

Mike put out a plea for anyone willing to take on the duties of the President, Vice-President, and Treasurer. Only one member, Bill Lettow, volunteered to be vice-president. Thank you Bill! The other positions are still open for volunteers. Bill Potorti will be taking over as Flash! editor.

The dates for the next meetings were under discussion. May 18th will be the May meeting.

A tribute was paid to Larry Weide for his past work in the club, as well as his sale and donation of part of his collection. Larry is enjoying his new life and has joined a radio club in Alameda. Discussion of making a plaque for Larry is ongoing. Wayne Russert was also thanked for storing much of Larry's remaining collection while it was being dispersed. Rob Beyer awarded Wayne with a DVD of Elvira (see the story in this issue).

Bill Lettow took over officiating the 2nd half of the meeting

There was some discussion about the shortcomings of our e-group in reaching everyone. Suggestions were floated about using Mail Chimp, Constant Contact or another program. Investigations are underway.

Bill Lettow presented members with 8 great designs he produced for a new logo for the club.

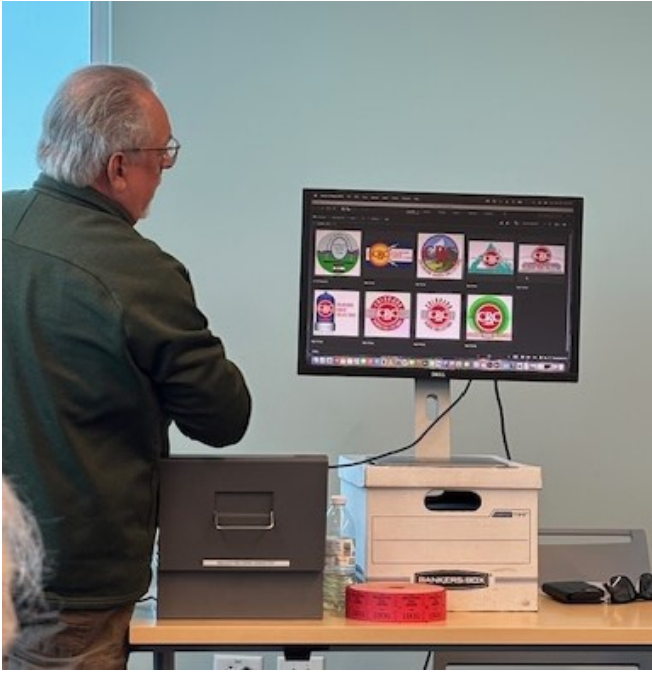

After the break, a vote was taken, and this will be our new logo going forward:



Everyone who brought in a shirt to the meeting will have this logo embroidered on the shirt, paid for by the club. The shirts may be ready by the next meeting. If not, they should be ready to be picked up at the Vintage Voltage show in April.



Speaking of which...Once again, Richard Kubersky and Ralph Brands have volunteered to be show coordinators at the Vintage Voltage Expo. This year it will be held at

the National Western Complex on April 13th. More information will be forthcoming at the next meeting, and in the e-group and the Facebook group.

The date for the club auction and picnic has tentatively been set for August 17th.

Also attending the meeting were Betty Henry and Nikki Cox. Betty's husband passed away and left a radio collection as well as numerous parts. They've gone through a great deal of effort in inventorying his collection, and would like help selling it off. We will try to find the best way for her to do that.



(News Continued)

### Some interesting things on the raffle table



### Show 'n Tell

Steve Touzalin brought in his Westinghouse WR150 radio from 1938 that he had restored. He explained some of the idiosyncrasies this set had and how he dealt with them.



Rich Kuberski brought in his tube tester and coke bottle radio that are described elsewhere in this issue



Photo courtesy of Bill Kohl

# National Western Complex

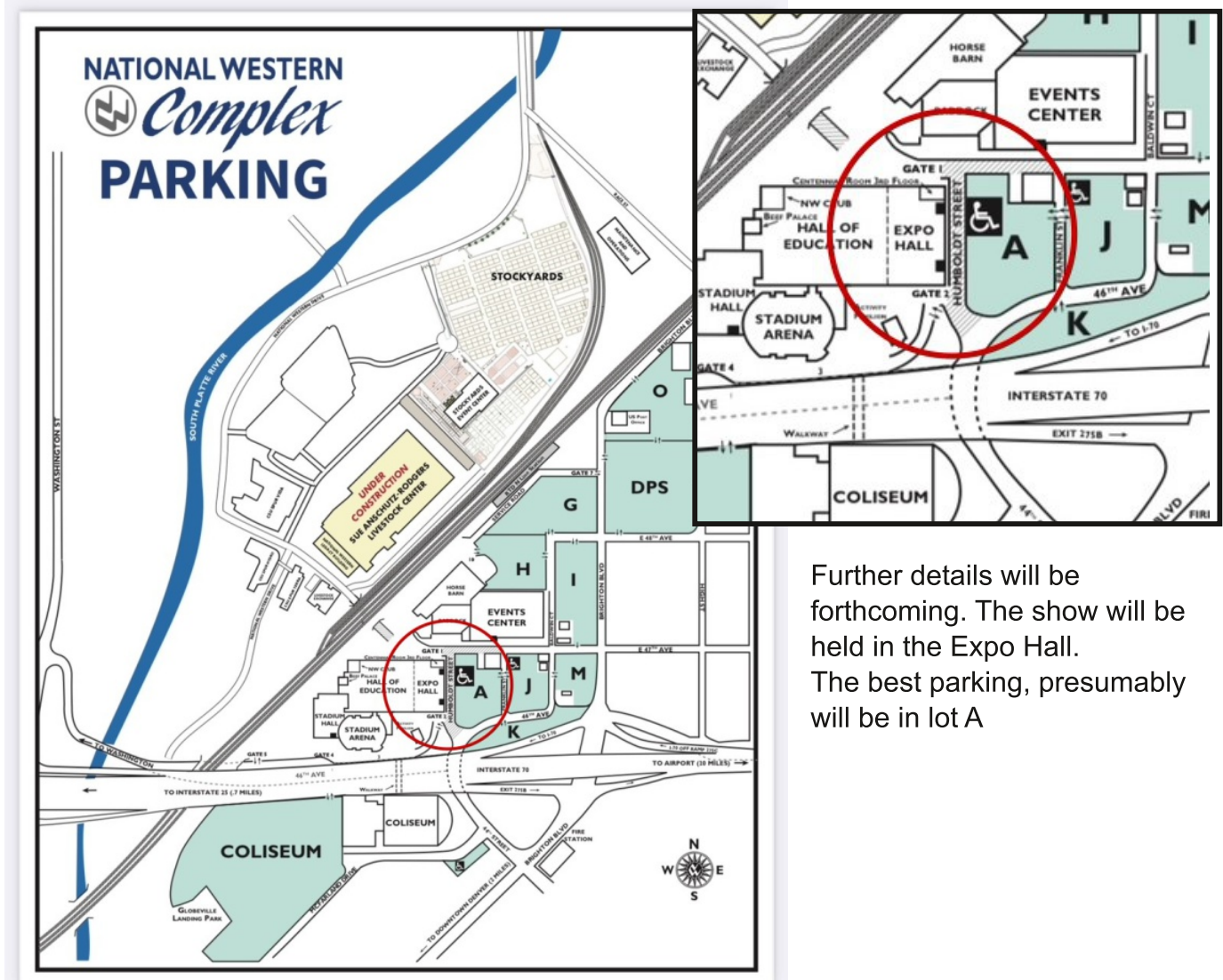

Further details will be forthcoming. The show will be held in the Expo Hall. The best parking, presumably will be in lot A

# Classified Ads

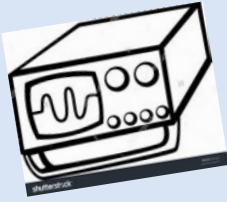

Ads are free for CRC members. To place an ad send your ad description along with personal contact information to the Flash Editor or one of the CRC officers

**Acme Tube Supply**  
Sean Duffy  
(573) 999-6187  
facebook.com/acmetubesupply acmetubesupply.com

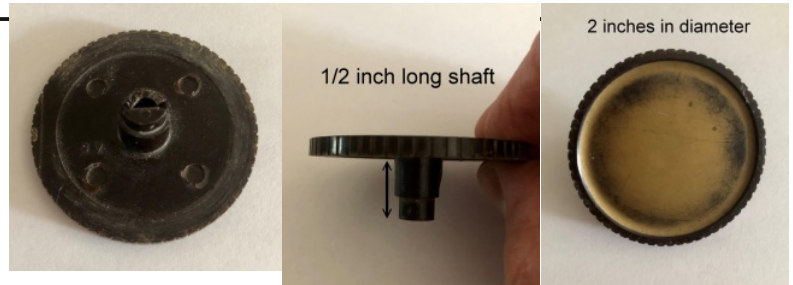

WANTED: large knobs for RCA 9Y51 Radio/Phonograph.  
Contact Bill Potorti at billpot@gmail.com

**March 16th Meeting is at the Highlands Ranch Library, Event Hall A at 1PM  
9292 S. Ridgeline Blvd.**

